

REVISIONS			
LTR	DESCRIPTION	DATE	APPROVED
—	INITIAL RELEASE		H D

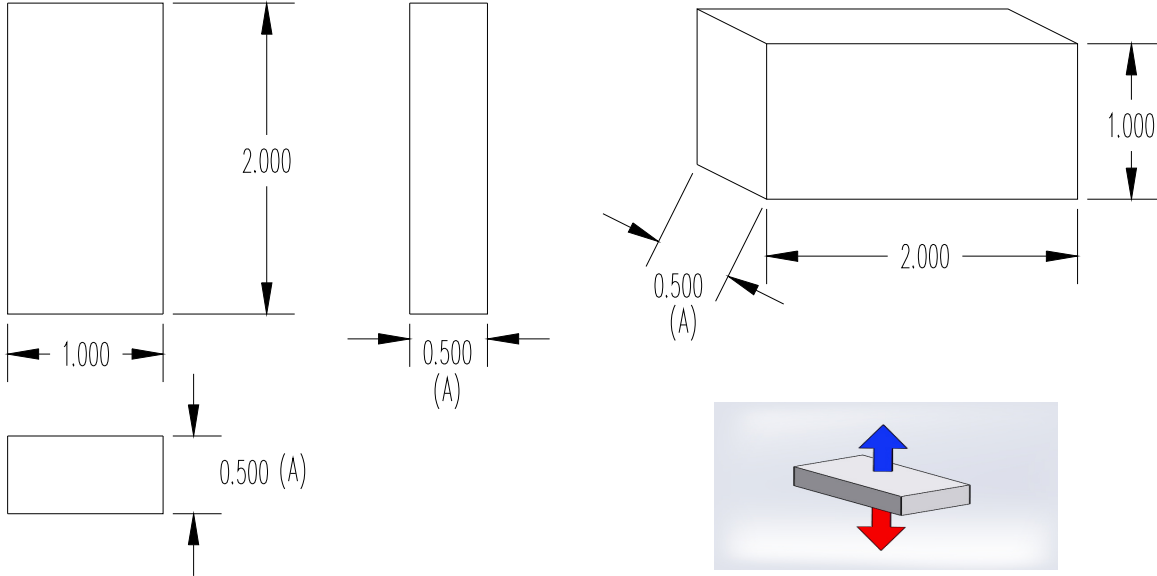

UNLESS OTHERWISE SPECIFIED DIMENSIONS ARE IN INCHES	
TOLERANCES:	
FRACTIONS:	$\pm 1/64$
DECIMALS:	± 0.015
ANGLES:	$\pm 1^\circ$
MATERIAL:	NdFeB
FINISH:	NiCuNi

RADIAL MAGNETS INC.			
108B NW 20th St. BOCA RATON, FL 33431 (561)392-2103			
SHAPE BLOCK	STRENGTH N42	PLATING NiCuNi	SIZE AND DIRECTION OF MAGNETIZATION (A) 1" x 2" x 1/2"
SIZE A	PART # 8309	DRAWING # RM8309	REVISION -
SCALE 1 : 1	DRAWN: CG	CHECKED: HD	APPROVED: HD PAGE 1 OF 1